

INTERIOR DOWNLIGHT

CEILING RECESSED · SPRING MOUNTING

# TOP 5 S - FIX

Square lighting fixture with anti-glare ring and beam angle options for different light distributions. TOP 5 Series combines the best light quality with an attractive look in a very small size.

Materials: hard anodised aluminium body and anti-glare, with PMMA lens.

Finishes: custom colours available in several palettes, including matte or gloss varnish, for anti-glare and frame. Suggested anodised black anti-glare maximises visual comfort.

Applications: suitable for accent lighting and general lighting of small areas, depending on selected beam angle.

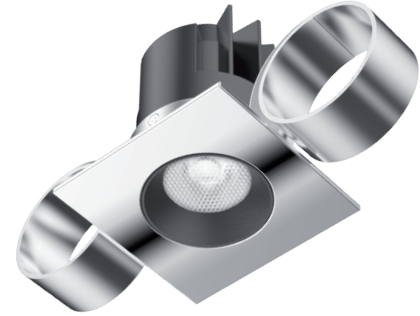

DRAWING

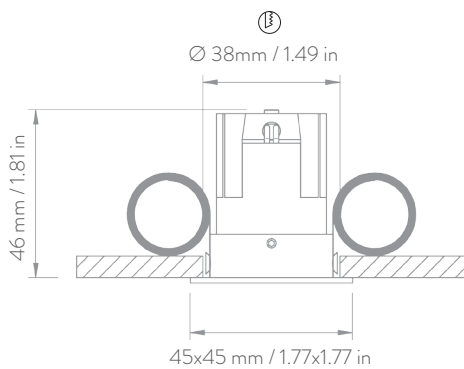

PHOTOMETRIC DIAGRAMS

**LENS: NARROW  
BEAM: 15°**

Lumen: 280  
Watt: 4  
Lm/W: 70  
CCT: 3000K  
CRI: 92 TYP

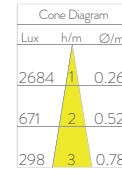

**LENS: MEDIUM  
BEAM: 25°**

Lumen: 311  
Watt: 4  
Lm/W: 78  
CCT: 3000K  
CRI: 92 TYP

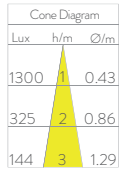

**LENS: WIDE  
BEAM: 36°**

Lumen: 264  
Watt: 4  
Lm/W: 66  
CCT: 3000K  
CRI: 92 TYP

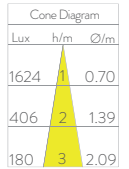

Note : according to the choice of accessories (honeycomb or sanded glass), please consider the implications on the lumen output and the luminous distribution.

BODY FINISHES

ACCESSORIES

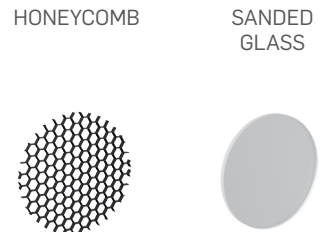

ITEMS	LENSES	COLOR TEMP.	POWER SUPPLY	BODY FINISHES	ACCESSORIES
CODE	NARROW MEDIUM WIDE	2700K 3000K 4000K	CLL V <sub>dc</sub> 24-32 DRIVER INCLUDED CSL Vf 11.3 If 350 mA DRIVER NOT INCLUDED	CHROMED ALUMINUM LACQUERED RAL9010 GLOSS LACQUERED MATTE BLACK ANTIQUE BRONZE	HONEYCOMB SANDED GLASS
20TOP5SFIX	NB - MB - WB	2 - 3 - 4	D - N	CH - LA - LB - AB	HC - SG

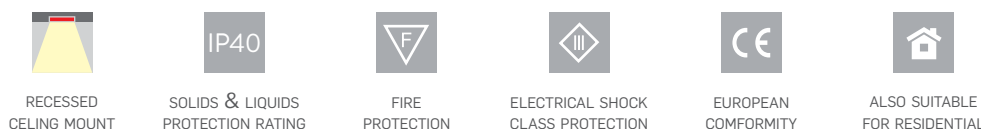

Note: Depending on the choice of finish, thickness of the product can vary up to 0,2 mm. Information provided with this document may be subject to change at any time without notice.