

SNAKE SIDE WHITE

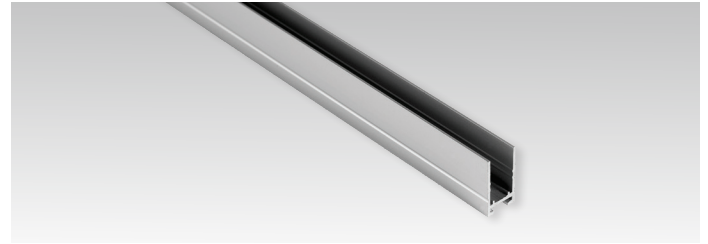
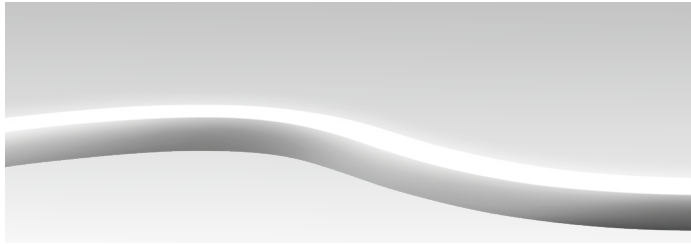

Snake product information

IP68 flexible STRIP LED light line fully encapsulated in polyurethane compound. Resistant to water, UV radiation, abrasion and chemicals. Very bright and homogeneous illumination over the entire light emitting surface also in curve form. Clear curved or linear lines and light-emitting surface enables a flush installation in ceilings, walls and furniture. The SNAKE are provided with 40 cm of cable without connectors from both sides; the cable feed enables a shadow-free alignment.

Technical data

Watt/Meter	10	Voltage	24VDC
Led/Meter	140	IP	68
Lumen/Meter @3000K	520	Cut	50 mm
CCT	2700K 3000K 4000K 6000K	Ambient temp.	-30°C ~ +50°
<i>Color correlated temperature</i>			
CRI	> 80		
<i>Color rendering index</i>			

Standard lengths

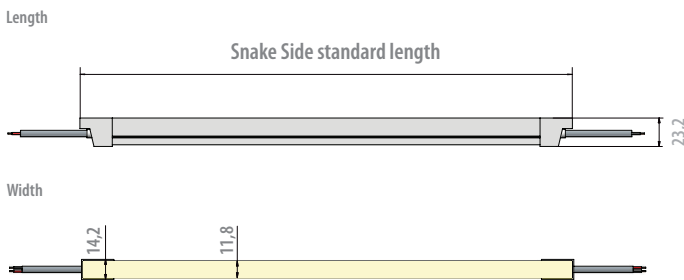

Codes

Snake Side standard length (1030 mm)	83 SNAKESIDE B 1030 + CCT*
Snake Side standard length (2030 mm)	83 SNAKESIDE B 2030 + CCT*
Snake Side standard length (3030 mm)	83 SNAKESIDE B 3030 + CCT*
Snake Side standard length (4030 mm)	83 SNAKESIDE B 4030 + CCT*
Snake Side standard length (5030 mm)	83 SNAKESIDE B 5030 + CCT*

*only the first three numbers (270, 300, 400, 600)

Aluminium mounting accessory product information

Profile material: Anodised aluminium
 Single extrusion profile various possible installations.
 Standard length: 2m

Technical data

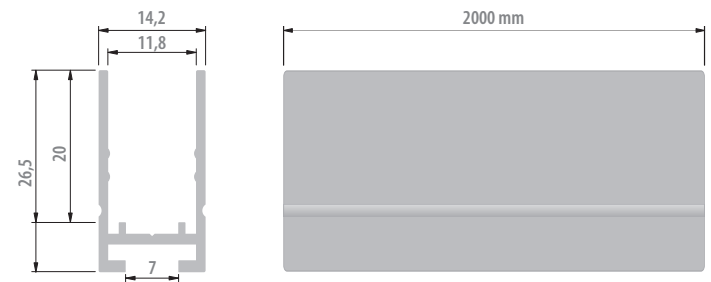

Standard and cutting lengths

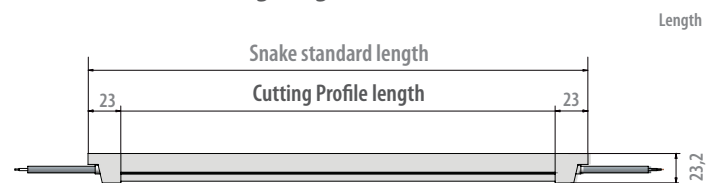

Snake standard length	Cutting Profile lengths
1030 mm	984 mm
2030 mm	1984 mm
3030 mm	2984 mm
4030 mm	3984 mm
5030 mm	4984 mm

Codes

Profiles Side standard length (2000 mm)	85 SNAKE SIDE 2000AAN
---	-----------------------

WARNING: how to bend

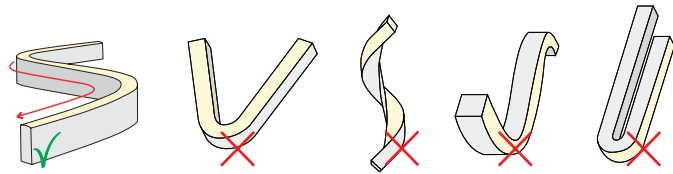

✓ Correct

✗ Do not bend this way.
the LED strip will break immediately

Max bending Radius

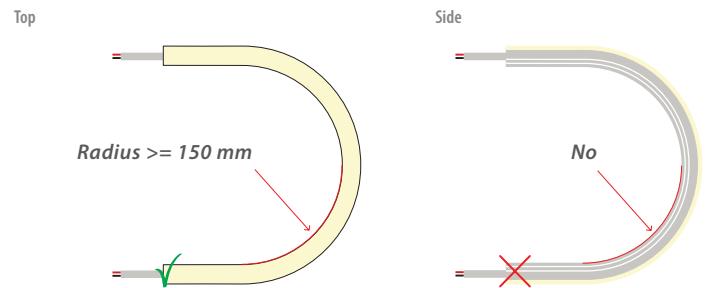

Mounting system

Radius	Cut	Cutting blade dimensions
600 mm	25 mm	1,5 mm
500 mm	25 mm	2,5 mm
400 mm	25 mm	3,5 mm
300 mm	25 mm	4,5 mm

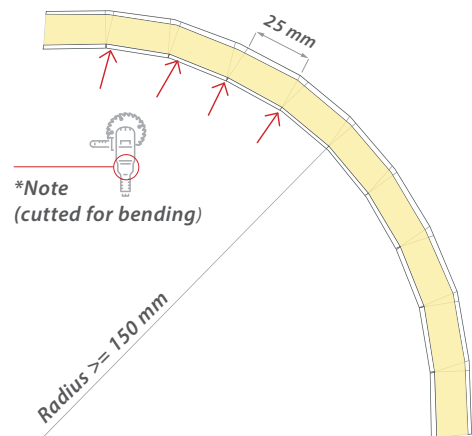

Mounting Bracket

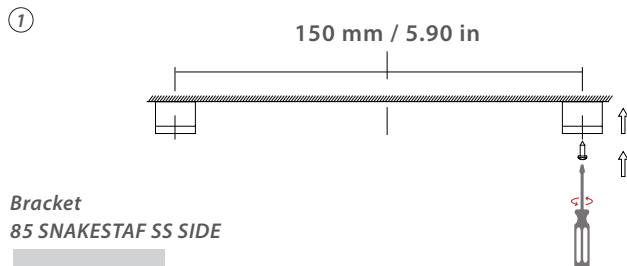

Bracket
85 SNAKESTAF SS SIDE



Descriptons:
SNAKE bracket set, stainless steel

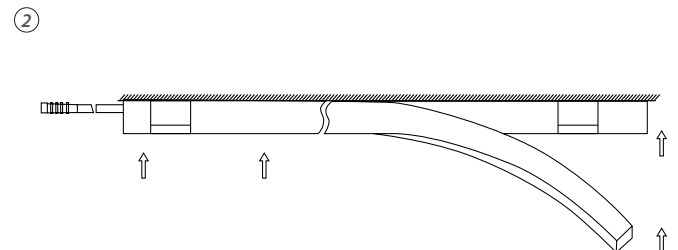

Wiring diagram

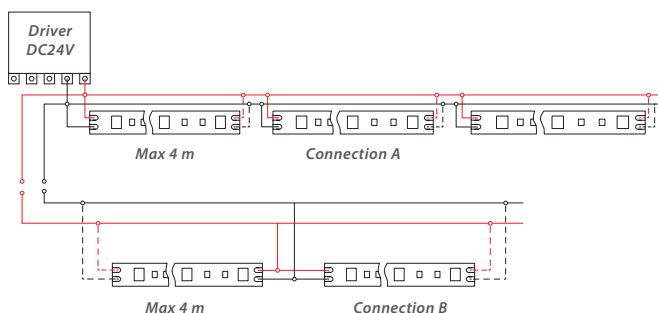

EUROPEAN
CONFORMITY



RESTRICTION OF HAZARDOUS
SUBSTANCES DIRECTIVE



DIMMABLE

Any cutting process made by anyone outside of Cantalupi srl voids the product's warranty.
Information provided with this document may be subject to change at any time without notice.