

for Interiors

SNAKE SIDE WHITE



IP68 FLEXIBLE STRIP LED LIGHT LINE FULLY ENCAPSULATED IN POLYURETHANE COMPOUND. RESISTANT TO WATER, UV RADIATION, ABRASION AND CHEMICALS. VERY BRIGHT AND HOMOGENEOUS ILLUMINATION OVER THE ENTIRE LIGHT EMITTING SURFACE ALSO IN CURVE FORM. CLEAR CURVED OR LINEAR LINES AND LIGHT-EMITTING SURFACE ENABLES A FLUSH INSTALLATION IN CEILINGS, WALLS AND FURNITURE. THE SNAKE ARE PROVIDED WITH 40 CM OF CABLE WITHOUT CONNECTORS FROM BOTH SIDES; THE CABLE FEED ENABLES A SHADOW FREE ALIGNMENT.

TECHNICAL DATA

WATT/METER	10	VOLTAGE	24vdc
LED/METER	140	IP	68
LUMEN/METER @3000K	420	CUT	50mm
CCT	2700K/3000K/4000K/6000K	AMBIENT TEMP.	-25°C ~ +65°C
CRI	>80		

CUSTOM: (IT IS POSSIBLE TO REQUEST)

- A SINGLE CABLE EXIT *
- DIFFERENT TYPES OF CABLE EXIT

*WE SUGGEST TO USE 2 CABLE EXITS FOR LENGTHS GREATER THAN 2000mm

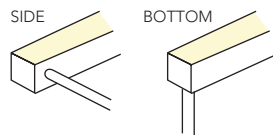

DRAWINGS

STANDARD: 2 SIDE CABLE EXIT - 400mm CABLE ON BOTH SIDES

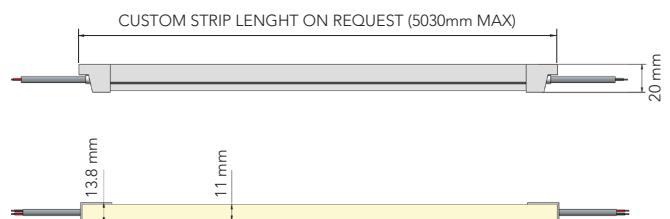

NOTE: THE CUSTOM LENGTHS YOU PROVIDE HAVE TO BE CHECKED AND CONFIRMED BY US IN ORDER TO PROVIDE THE PRODUCT WITHOUT ANY SHADOW AREAS ON THE ENDS

HOW TO BEND

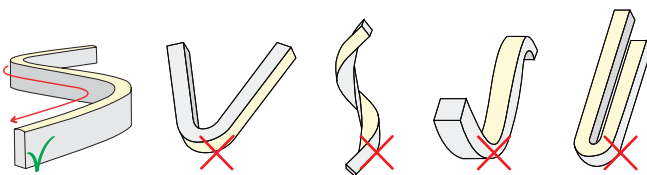

- ✓ CORRECT
- ✗ DO NOT BEND THIS WAY

MAX BENDING RADIUS

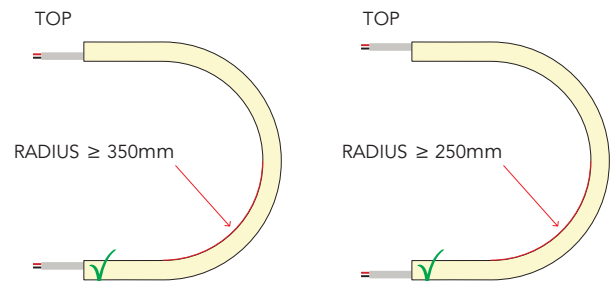

CODES

SNAKE SIDE WHITE

INDICATE THE DESIRED LENGTH (mm) IN THE REQUEST

83 SNAKESIDEBCUS + CCT ¹

¹CCT CODES : 2700 (2700K) / 3000 (3000K) / 4000 (4000K)



DIMMABLE LIGHT



HIGH LIGHT OUTPUT



RESISTANT TO SOLVENTS



UV PROTECTED



TEST REPORT



FC CERTIFIED



ETL CERTIFIED



CE CERTIFIED

ALUMINUM MOUNTING PROFILE

PROFILE MATERIAL: ANODIZED ALUMINUM
 STANDARD LENGHT: CUSTOM LENGHT ON REQUEST

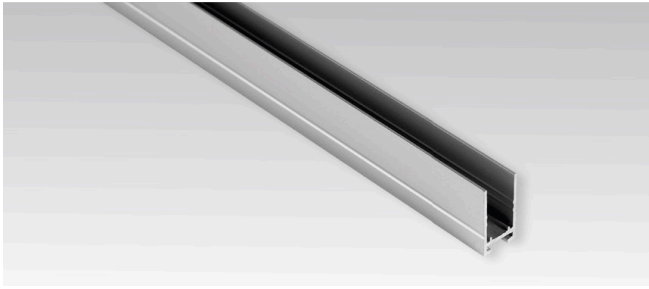

TECHNICAL DATA

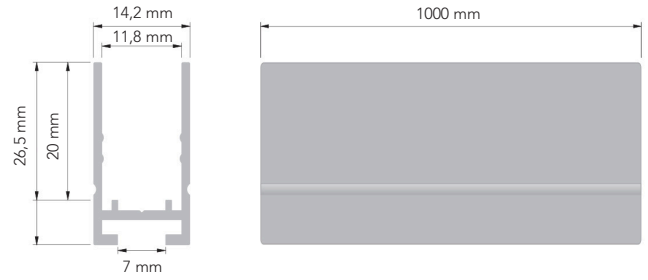

CODES

SNAKE SIDE MOUNTING PROFILE (1000mm)

85 SNAKESIDE 1000AAN

MOUNTING SYSTEM: FLEXIBLE PROFILE FOR BENDING PARTS

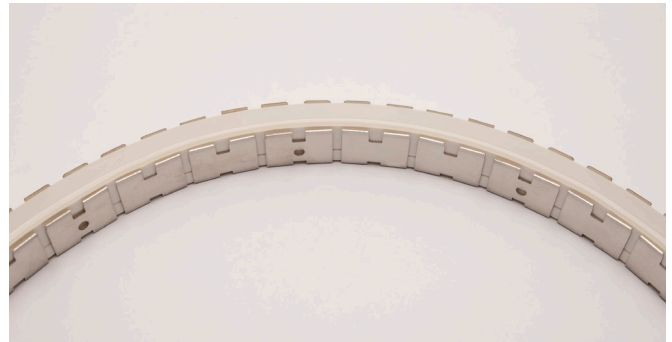
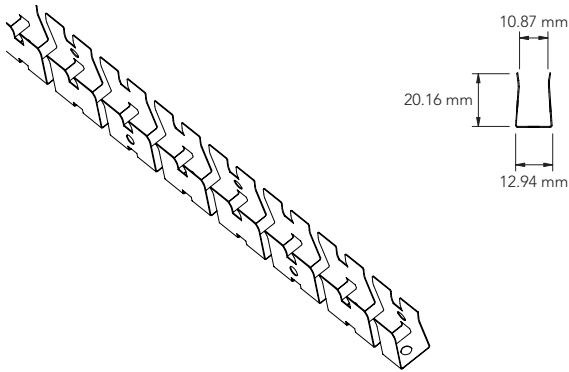

CODES

SNAKE SIDE BENDING MOUNTING PROFILE (970mm) **85 SNAKESIDE CUR970SS**

MOUNTING BRACKET

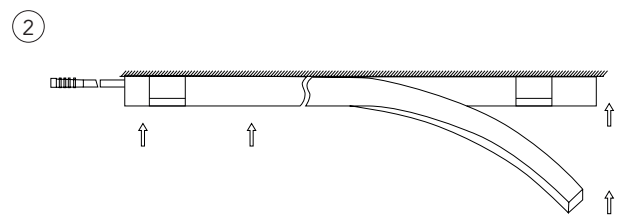
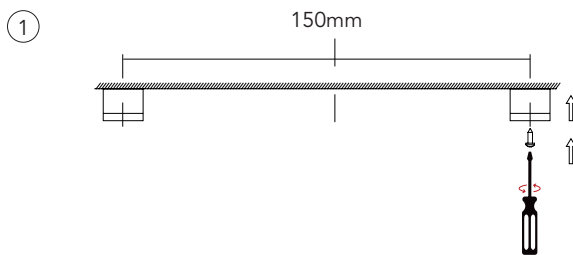

3 STAINLESS STEEL BRACKETS FOR EACH METER OF SNAKE ARE INCLUDED IN THE SHIPMENT, EXTRA BRACKET SET ON REQUEST

CODES

STAINLESS STEEL BRACKETS

85 SNAKESTAF SS SIDE

WIRING DIAGRAM

