

for Interiors

SNAKE TOP WHITE



IP68 FLEXIBLE STRIP LED LIGHT LINE FULLY ENCAPSULATED IN POLYURETHANE COMPOUND. RESISTANT TO WATER, UV RADIATION, ABRASION AND CHEMICALS. VERY BRIGHT AND HOMOGENEOUS ILLUMINATION OVER THE ENTIRE LIGHT EMITTING SURFACE ALSO IN CURVE FORM. CLEAR CURVED OR LINEAR LINES AND LIGHT-EMITTING SURFACE ENABLES A FLUSH INSTALLATION IN CEILINGS, WALLS AND FURNITURE. THE SNAKE ARE PROVIDED WITH 40 CM OF CABLE WITHOUT CONNECTORS FROM BOTH SIDES; THE CABLE FEED ENABLES A SHADOW FREE ALIGNMENT.

TECHNICAL DATA

WATT/METER	10	VOLTAGE	24VDC
LED/METER	140	IP	68
LUMEN/METER @3000K	820	CUT	50mm
CCT 2700K/3000K/4000K/6000K		AMBIENT TEMP.	-25c ~ +65°c
CRI	>80		

DRAWINGS

STANDARD: 2 SIDE CABLE EXIT - 400mm CABLE ON BOTH SIDES

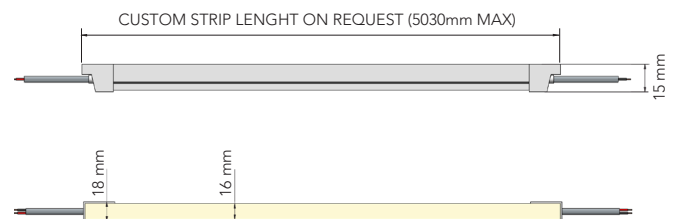

CUSTOM: (IT IS POSSIBLE TO REQUEST)

- A SINGLE CABLE EXIT *
- DIFFERENT TYPES OF CABLE EXIT

*WE SUGGEST TO USE 2 CABLE EXITS FOR LENGTHS GREATER THAN 2000mm

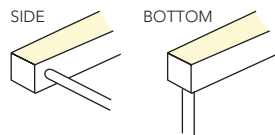

NOTE: THE CUSTOM LENGTHS YOU PROVIDE HAVE TO BE CHECKED AND CONFIRMED BY US IN ORDER TO PROVIDE THE PRODUCT WITHOUT ANY SHADOW AREAS ON THE ENDS

HOW TO BEND

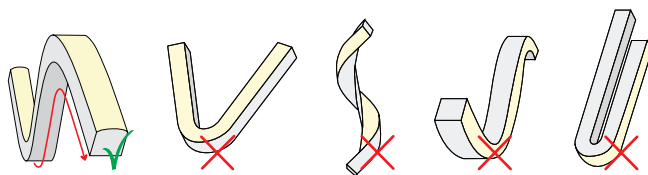

- ✓ CORRECT
- ✗ DO NOT BEND THIS WAY

MAX BENDING RADIUS

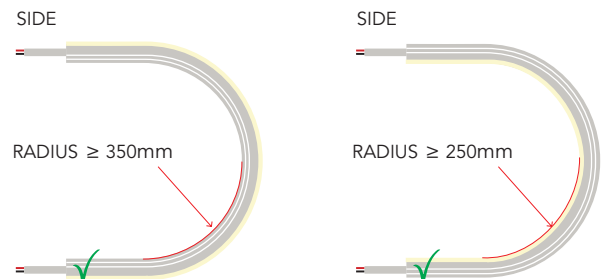

CODES

SNAKE TOP WHITE

INDICATE THE DESIRED LENGTH (mm) IN THE REQUEST

83 SNAKETOPBCUS + CCT ¹

¹CCT CODES : 2700 (2700K) / 3000 (3000K) / 4000 (4000K)



DIMMABLE LIGHT



HIGH LIGHT OUTPUT



RESISTANT TO SOLVENTS



UV PROTECTED



TEST REPORT



FC CERTIFIED



ETL CERTIFIED



CE CERTIFIED

ALUMINUM MOUNTING PROFILE

PROFILE MATERIAL: ANODIZED ALUMINUM
 STANDARD LENGHT: CUSTOM LENGHT ON REQUEST

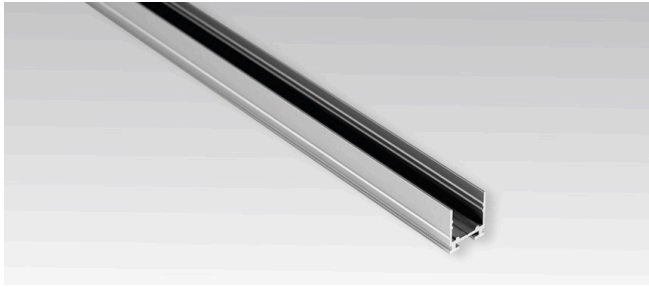

TECHNICAL DATA

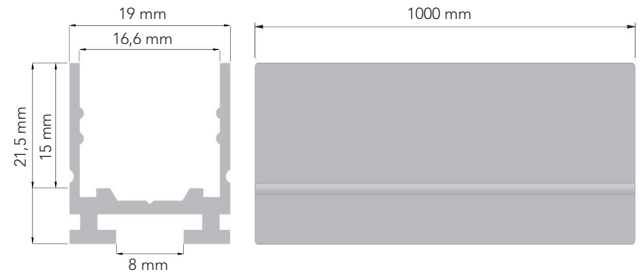

CODES

SNAKE TOP MOUNTING PROFILE (1000mm) **85 SNAKETOP 1000AAN**

MOUNTING SYSTEM: FLEXIBLE PROFILE FOR BENDING PARTS

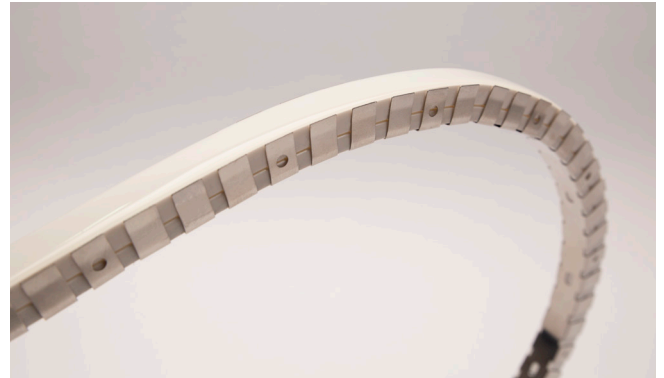
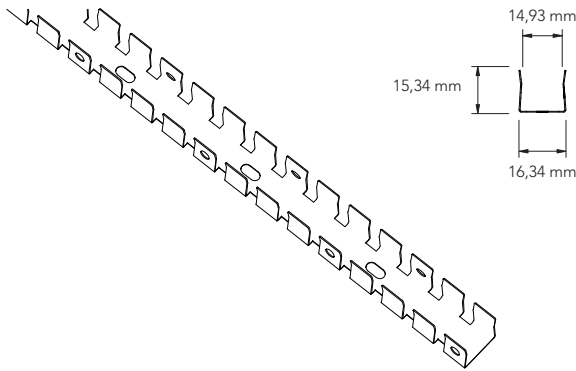

CODES

SNAKE TOP BENDING MOUNTING PROFILE (970mm) **85 SNAKETOP CUR970SS**

MOUNTING BRACKET

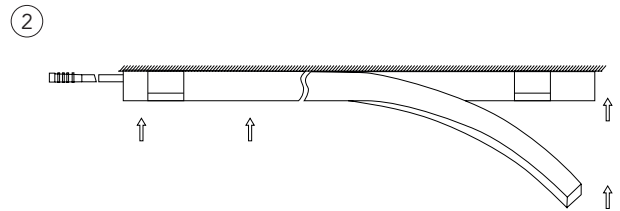
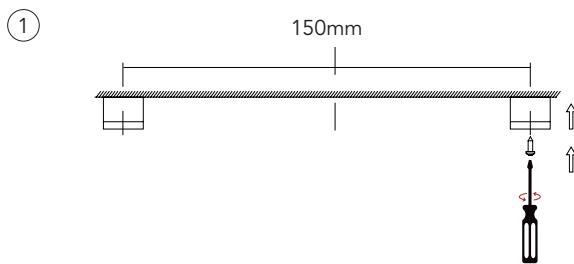

3 STAINLESS STEEL BRACKETS FOR EACH METER OF SNAKE ARE INCLUDED IN THE SHIPMENT, EXTRA BRACKET SET ON REQUEST

CODES

STAINLESS STEEL BRACKETS **85 SNAKESTAF SS TOP**

WIRING DIAGRAM

